



Model 1-624

SERVICE MANUAL

1-624 CIRCUIT DESCRIPTION

GENERAL

The 1-624 main chassis utilizes a double-sided P. C. board that comprises Royce's "semi-leadless" chassis. Main board circuitry consists of the r. f. and i. f. stages; audio, transmitter modulator and output stages. The diode matrix switching circuit board (D.M.C.) for the channel readout function, is stacked on the main chassis. The D.M.C. PCB also includes the crystal oscillator module which will be examined further, subsequently.

R. F. SECTION

Incoming r. f. signals from the antenna jack are applied through T101 to the base of the r. f. amplifier 2SC674 (Q101). The input is diode protected against transients. R. F. Gain control transistor Q110 acts as a variable resistance controlling the signal input level to Q101. The output of Q101 is applied to the base of the first mixer 2SC710 (Q102) as is the 37 MHz output from the crystal oscillator unit. The mixing process provides the first i. f. frequency output (10.7 MHz) which, after passing through the 10.7 MHz filter (F101), is applied to the input of the second mixer 2SC711 (Q103). The crystal oscillator unit also provides an output of 10.1 MHz to the input of Q103. The mixing process then completes conversion to the 455 KHz second i. f. which is then applied to the 455 KHz i. f. filters (F102, F103).

A high degree of selectivity is achieved through the use of the dual i. f. filters, hence no tuned circuits are utilized in the three-stage i. f. strip consisting of 2SC711 (Q104, Q105), 2SA562 (Q106). The output of the detector 1S188 (D102) is then applied through a switchable noise gate (ANL function) to provide audio output to the volume control.

AUDIO SECTION

The audio signal from the volume control is applied to the first audio preamp 2SC372 (Q109). Providing the squelch is "off," the output of Q109 is applied to a second audio preamp 2SC735 (Q301). The output of Q301 feeds the audio driver I. C. TA7062P (Q302) which in turn drives the primary of driver transformer ETT-1001 (T2). The output is a push-pull stage consisting of T2 secondary, the audio output (and modulator) transistors 2SD330 (Q303, Q304), and the modulation and output transformer ETT-20015 (T1). In the receive mode, the audio output secondary of T1 drives the speaker via the switching relay NS2-P-DC12V (RL 1-2).

MODULATOR SECTION

The modulator section begins at the microphone input jack. In the transmit mode (pin 3 grounded at mic jack), the switching relay will be activated. The audio input (pin 1 mic jack) is applied to the base of the mic preamp 2SC372 (Q205). The signal then follows a similar progression from Q301 on through to the output as outlined in the AUDIO SECTION, preceding with two exceptions. The audio output winding is disconnected, and the output of the modulation transformer is applied to the transmitter driver and output stages. A negative feedback signal is developed by the "automatic modulation control" circuit from the modulation stage output. Modulation peaks in the output cause A.M.C. amplifier 2SB561 (Q204) to conduct, thus limiting the audio input level. Threshold of the circuit is controlled by the 10 K ohm mini-potentiometer VR201.

TRANSMITTER SECTION

The transmitter section is conventional and straightforward in design. The crystal oscillator unit provides a 27 MHz signal to the input of the predriver 2SC710 (Q201). Class A operation is employed in the Q201 drives the r. f. driver 2SC1018 (Q202) which in turn drives the r. f. final 2SC756 (Q203). Both the driver and final are operated class B. The output circuitry comprises a pi-loading, and low pass filter network (54 MHz). Associated circuitry consists of a tap on the r. f. output, rectified by D201 (1S188) to provide a signal for the r. f. meter, and the transmit-modulation indicator amplifier 2SC735 (Q206). A signal sampling circuit (D601, D602) also provide signal sources for the calibration and SWR meters.

DIODE MATRIX CIRCUIT

The D.M.C. unit performs the singular function of providing the necessary switching to display the channel position on the LED readout. Associated circuitry consists of a voltage regulator 2SD313 (Q401) and brightness switch. For additional particulars on the D.M.C. unit, refer to the board layout and pin functional descriptions.

SQUELCH — A.G.C.

The A.G.C. amplifier 2SC372 (Q108) operates on signals supplied by the detector output. The A.G.C. output is applied to the base of Q102 and Q104. The A.G.C. output also serves as a source for the squelch circuit transistor 2SC372 (Q107) which, when operational, biases Q109 off.

1-624

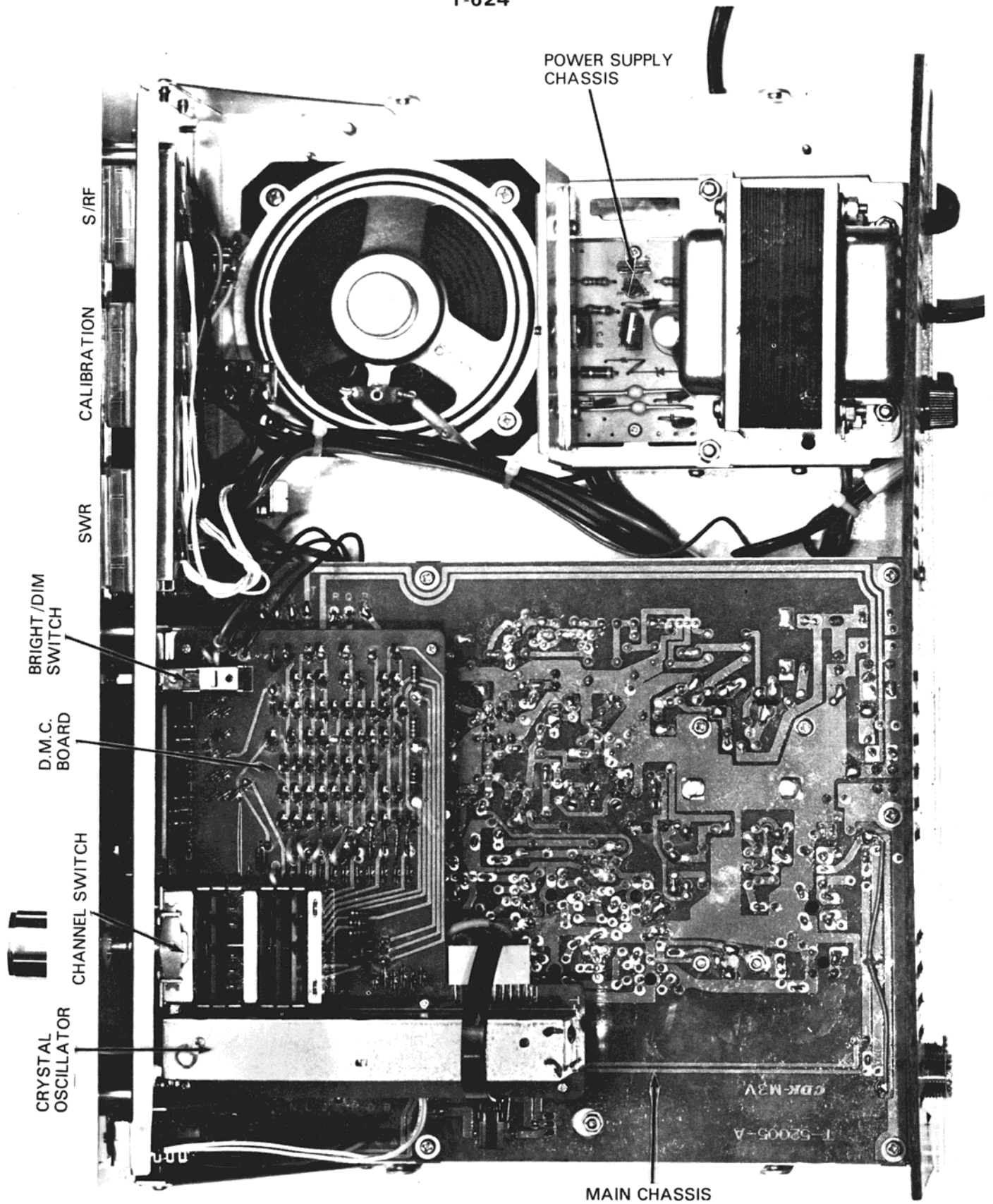

FIG. 1

1-624

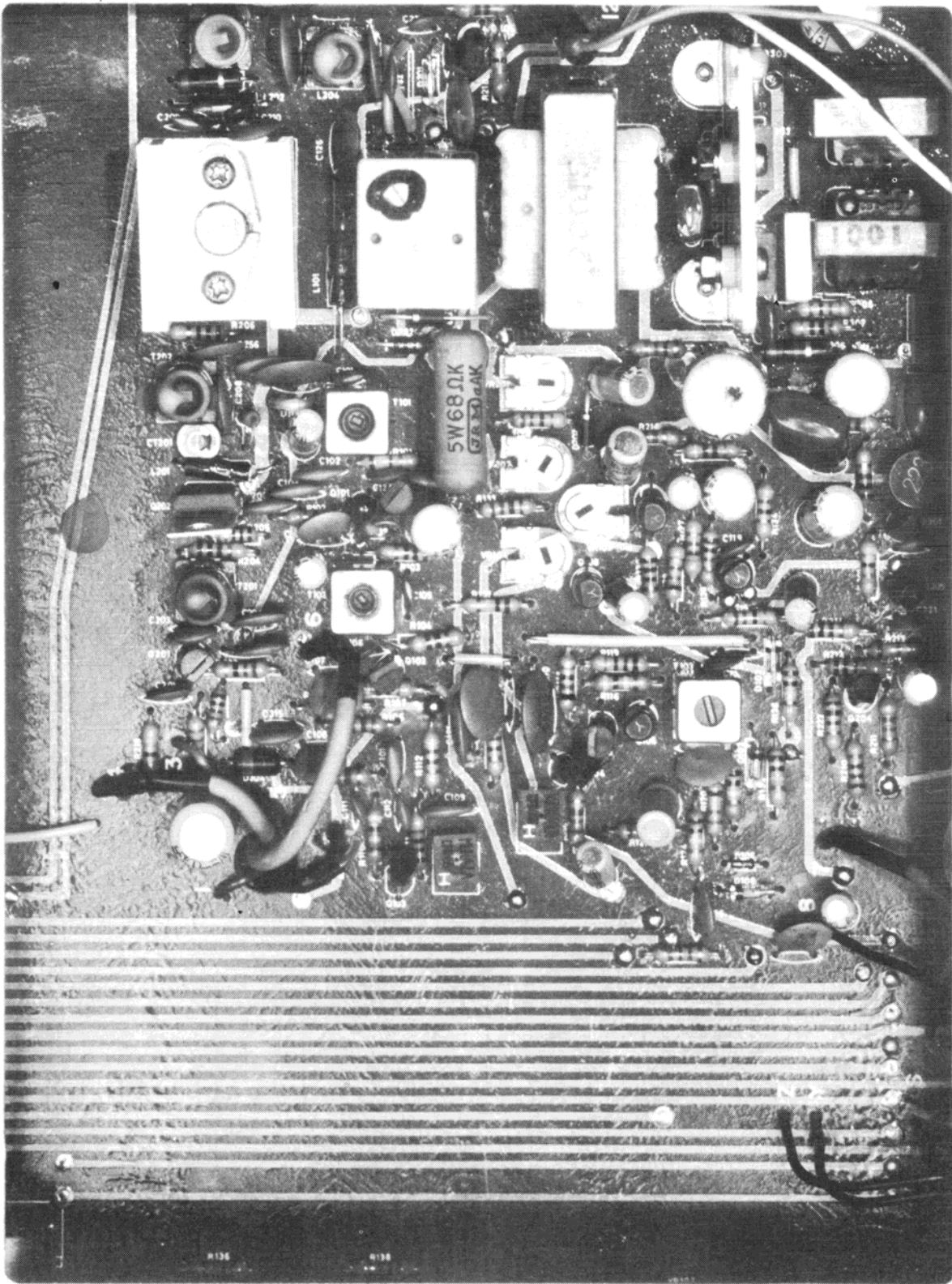
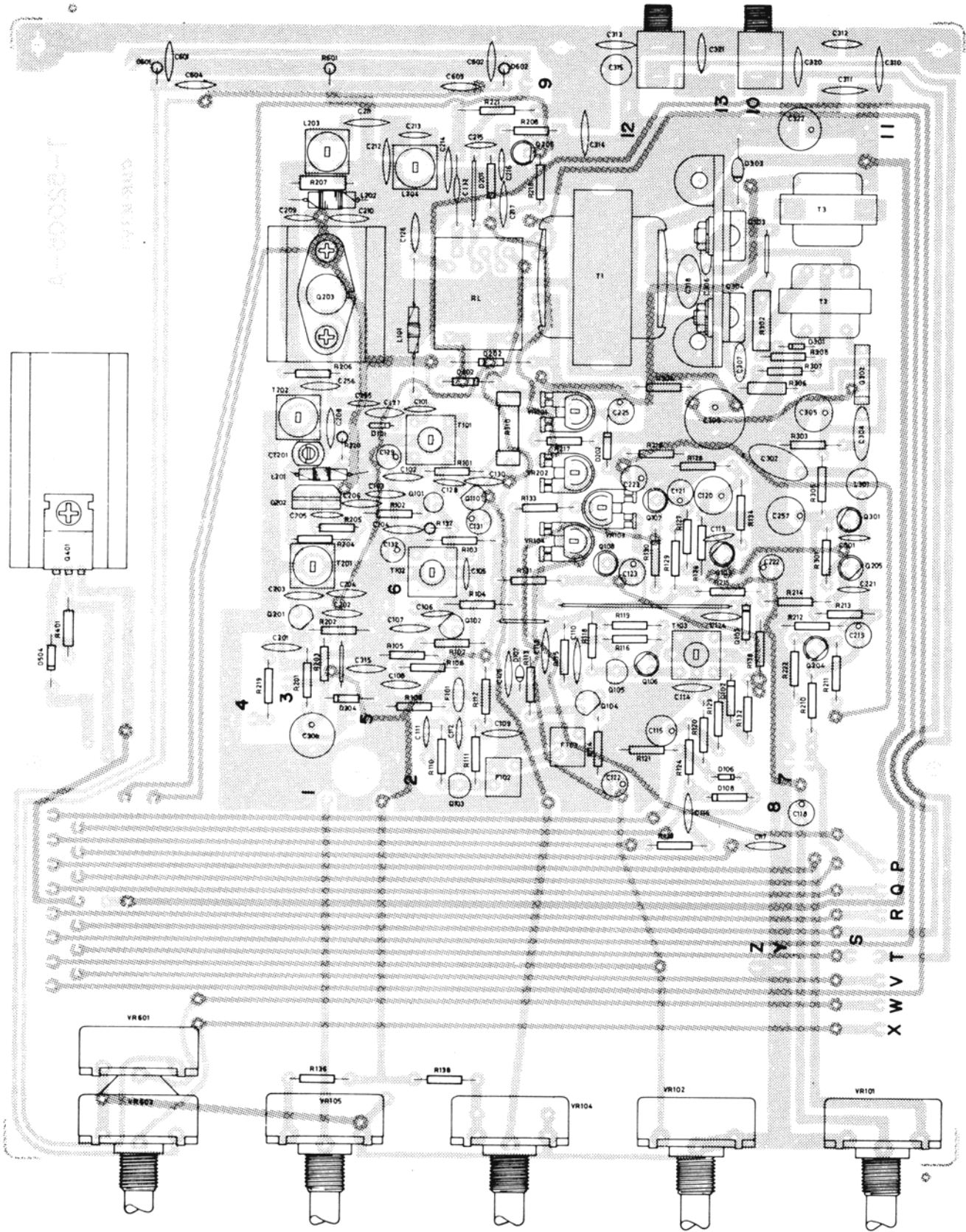
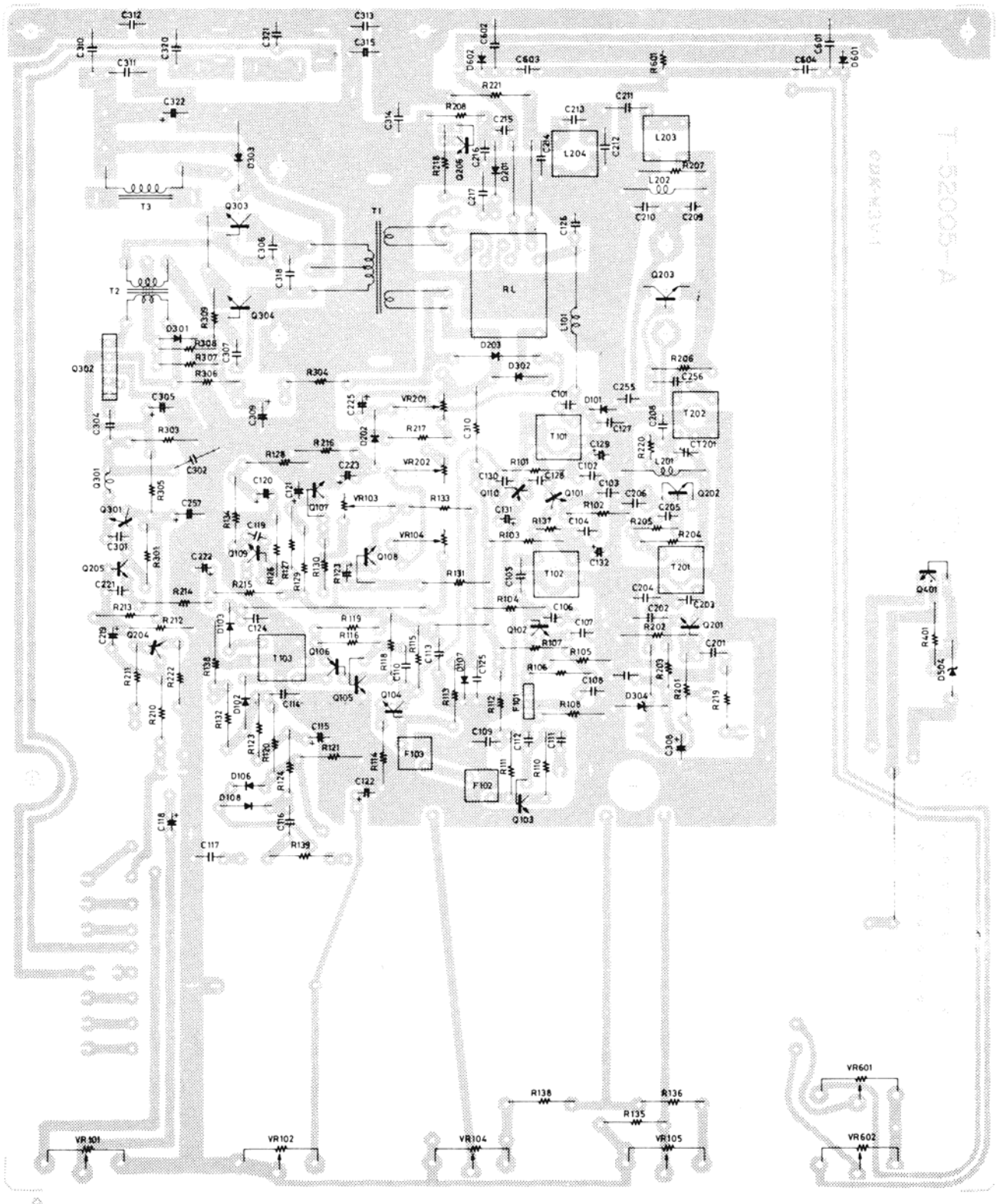

FIG 2

TOP VIEW



BACK VIEW



TOP VIEW

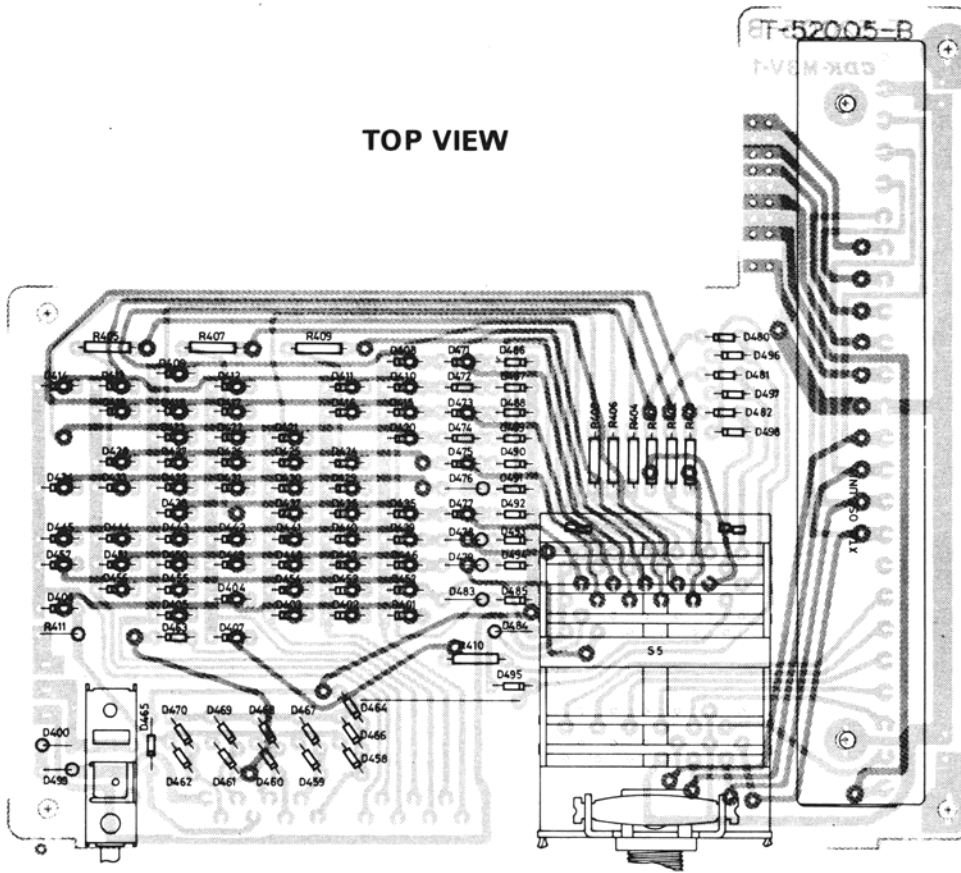

BACK VIEW

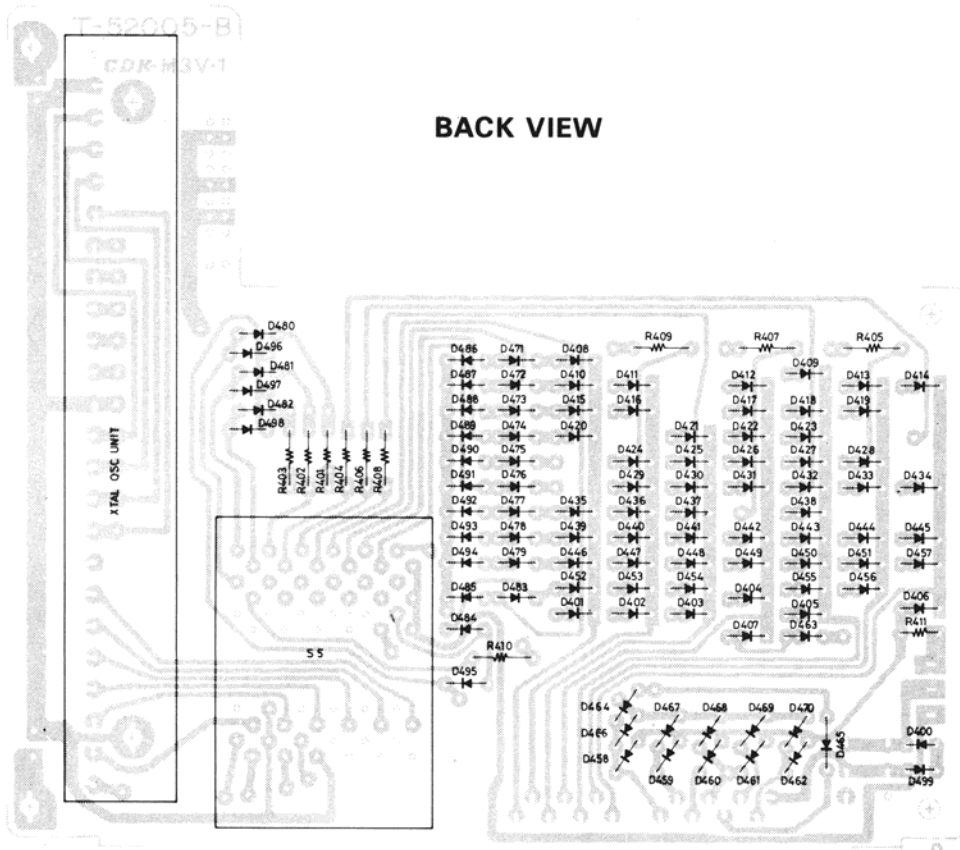

DISPLAY BOARD

FRONT VIEW

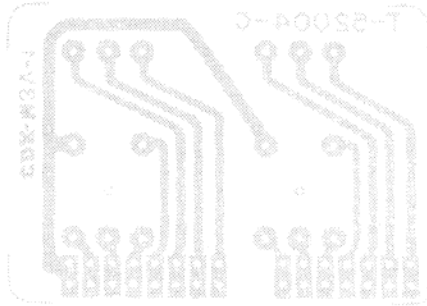

BACK VIEW

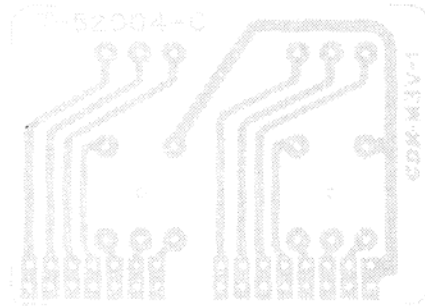

POWER SUPPLY PCB

TOP VIEW

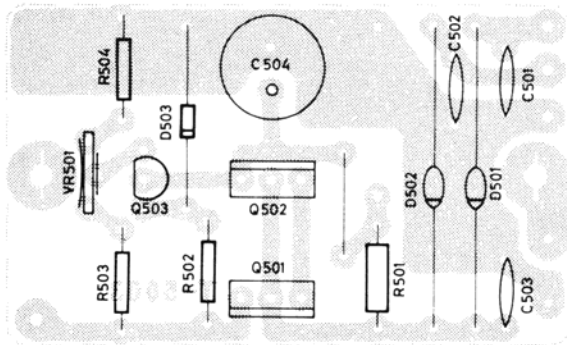

BACK VIEW

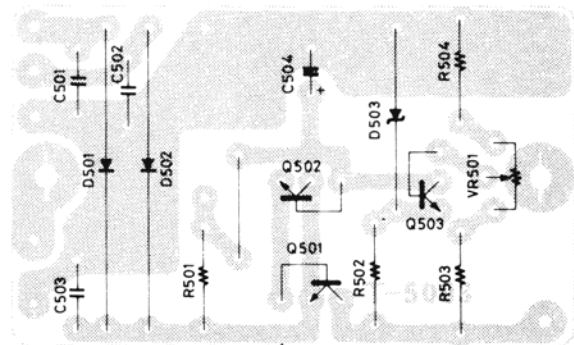

BLOCK DIAGRAM

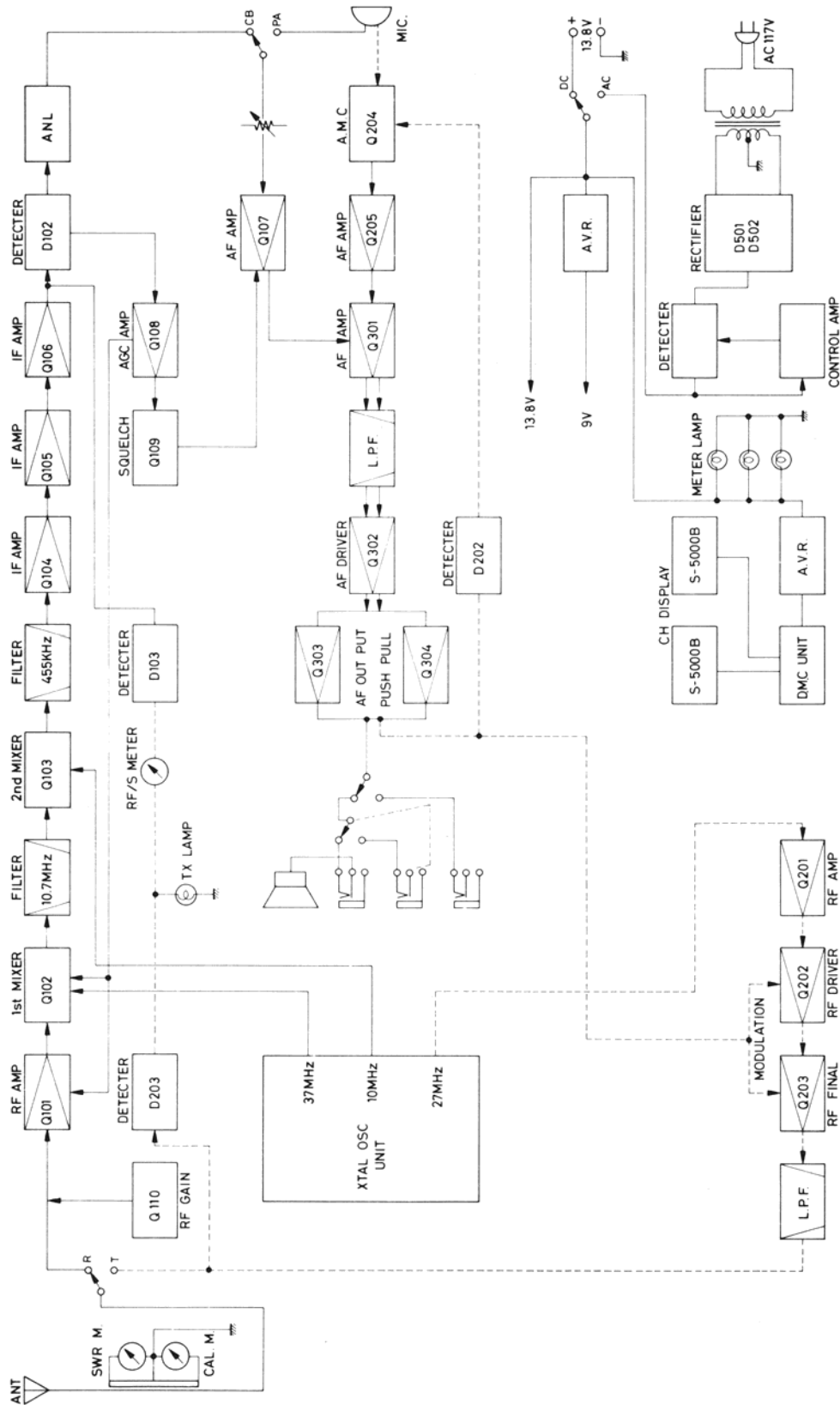

1-624 Voltage Chart

	RX			TX		
	Vb	Vc	Ve	Vb	Vc	Ve
Q 101	2.6	7.6	1.8			
Q 102	1.3	8.7	.9			
Q 103	.7	4.2	0			
Q 104	1.3	2.8	.6			
Q 105	.7	4.8	0			
Q 106	4.8	0	5.4			
Q 107	.7	.1	0 (Squelch On)			
	0	7.4	0 (No Squelch)			
Q 108	2.7	9.3	2.0			
Q 109	0	8.8	0 (Squelch On)			
	1.1	6.0	.5 (No Squelch)	1.2	5.0	1.2
Q 110	.1	0	0 (r.f. gain max.)			
	.8	.1	0 (r.f. gain min.)			
Q 201	2.2	13.6	9.4	1.7	13.6	1.4
Q 202					12	
Q 203					12	
Q 204						0
Q 205	4.2	6.0	9.3	4.3	4.5	3.6
Q 206	.1	13.6	0	.9	3.6	0
Q 301	6.0	10.2	5.3	4.5	10.4	3.9
Q 303	.7	13.7	.1	.7	13.7	.1
Q 304	.7	13.7	.1	.7	13.7	.1
Q 501	14.5	18.6	13.8			
Q 502	15.1	18.6	14.5			
Q 503	8.3	15.1	7.7			
Q 504	7.0	13.8	7.6			

	Mode	1	2	3	4	5
Q 302	RX	.8	.2	0	12.2	11.8
	TX	.8	.2	0	12.2	11.8

Crystal Oscillator Unit 2-5065

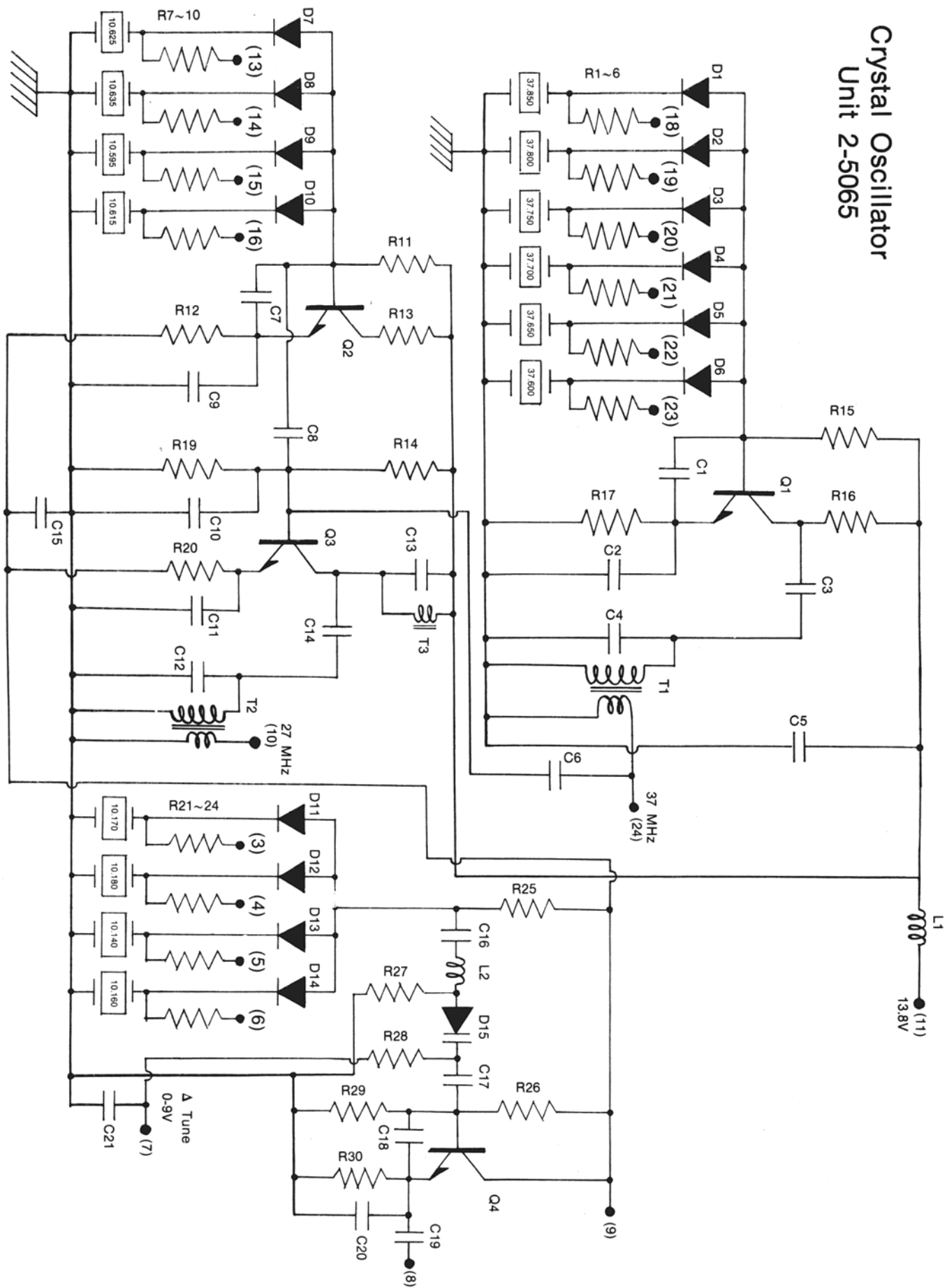

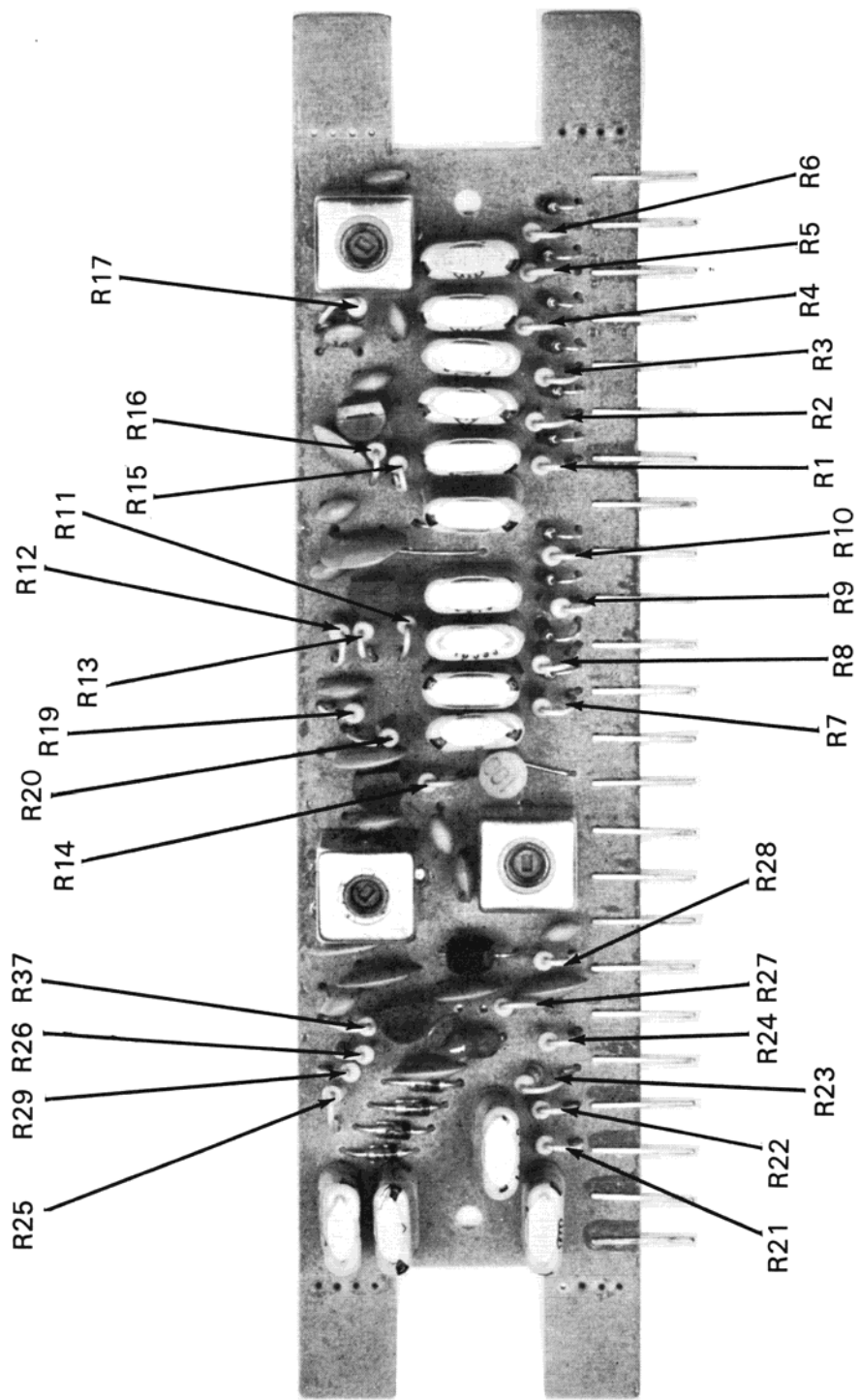

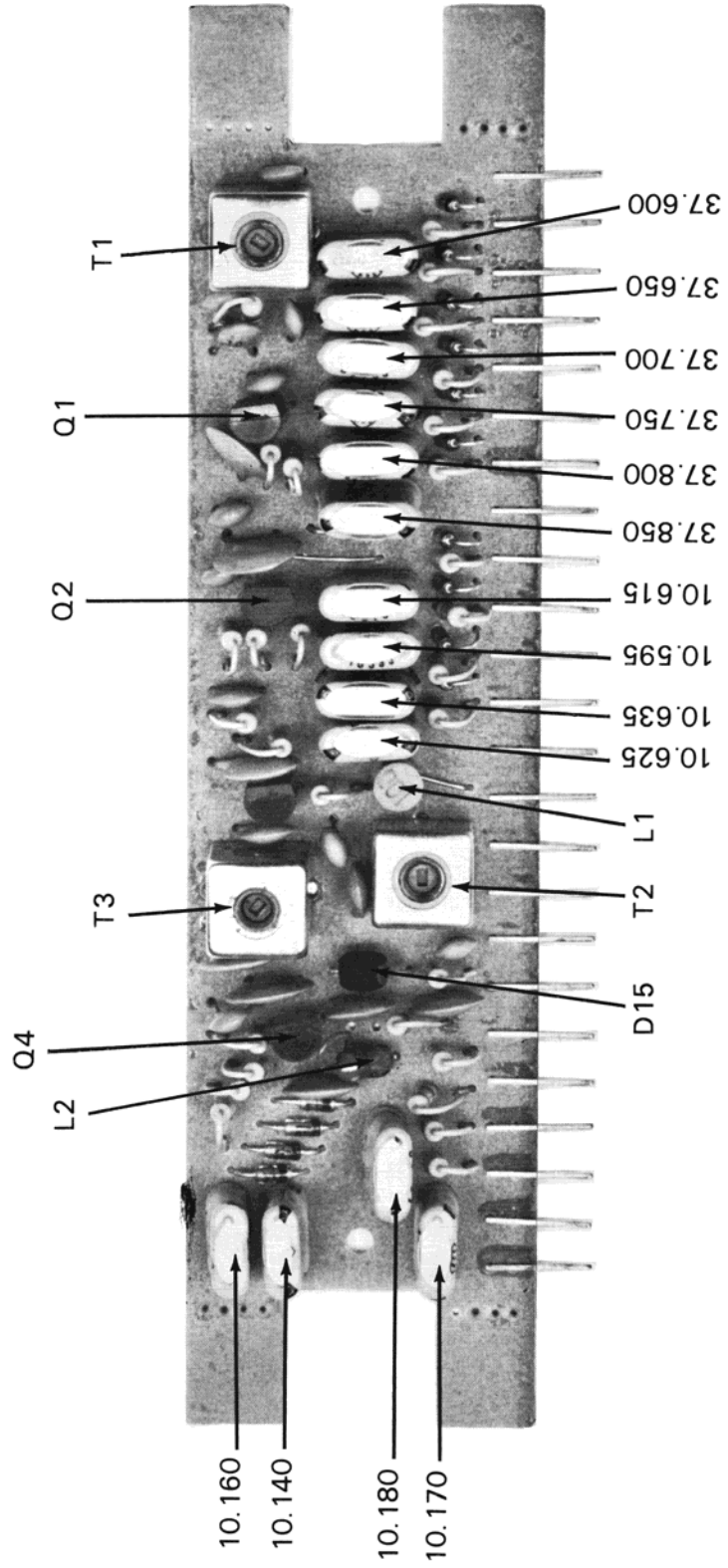

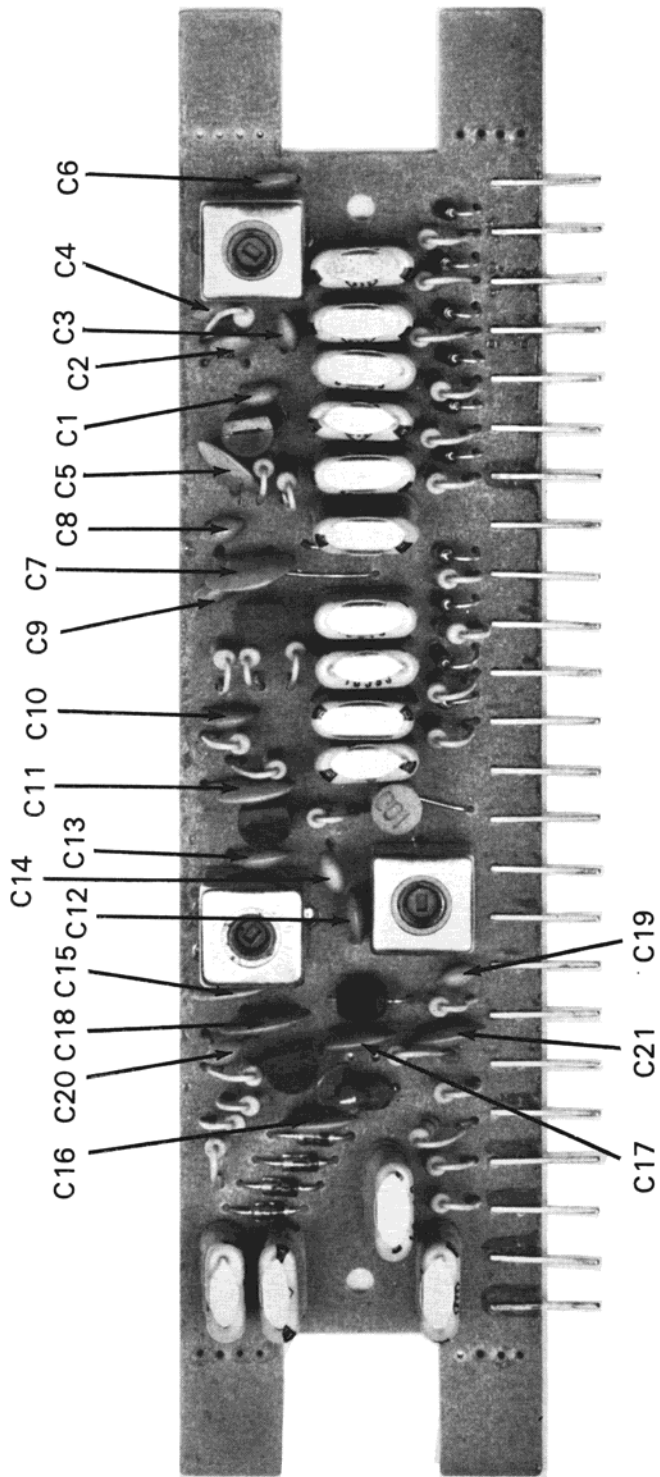

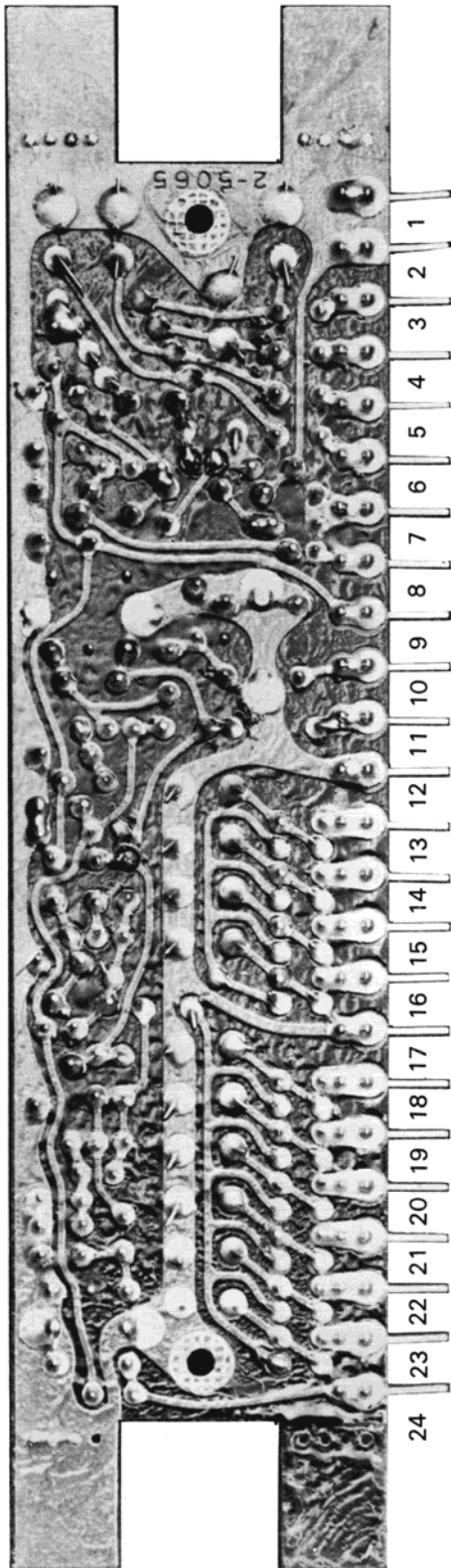

CRYSTAL FREQUENCY CHART

(A) Group 6 pcs.

X¹ 37.60 MHz
 X² 37.65 MHz
 X³ 37.70 MHz
 X⁴ 37.75 MHz
 X⁵ 37.80 MHz
 X⁶ 37.85 MHz

(B) Group 4 pcs.
 (Transmitting)

X⁷ 10.635 MHz
 X⁸ 10.625 MHz
 X⁹ 10.615 MHz
 X¹⁰ 10.595 MHz

(C) Group 4 pcs.
 (Receiving)

X¹¹ 10.18 MHz
 X¹² 10.17 MHz
 X¹³ 10.16 MHz
 X¹⁴ 10.14 MHz

CHANNEL	FREQUENCY (MHz)	COMBINATION (Transmit)	COMBINATION (Receive)
1.	26.965	X ¹ - X ⁷	X ¹ - X ¹¹
2.	26.975	X ¹ - X ⁸	X ¹ - X ¹²
3.	26.985	X ¹ - X ⁹	X ¹ - X ¹³
4.	27.005	X ¹ - X ¹⁰	X ¹ - X ¹⁴
5.	27.015	X ² - X ⁷	X ² - X ¹¹
6.	27.025	X ² - X ⁸	X ² - X ¹²
7.	27.035	X ² - X ⁹	X ² - X ¹³
8.	27.055	X ² - X ¹⁰	X ² - X ¹⁴
9.	27.065	X ³ - X ⁷	X ³ - X ¹¹
10.	27.075	X ³ - X ⁸	X ³ - X ¹²
11.	27.085	X ³ - X ⁹	X ³ - X ¹³
12.	27.105	X ³ - X ¹⁰	X ³ - X ¹⁴
13.	27.115	X ⁴ - X ⁷	X ⁴ - X ¹¹
14.	27.125	X ⁴ - X ⁸	X ⁴ - X ¹²
15.	27.135	X ⁴ - X ⁹	X ⁴ - X ¹³
16.	27.155	X ⁴ - X ¹⁰	X ⁴ - X ¹⁴
17.	27.165	X ⁵ - X ⁷	X ⁵ - X ¹¹
18.	27.175	X ⁵ - X ⁸	X ⁵ - X ¹²
19.	27.185	X ⁵ - X ⁹	X ⁵ - X ¹³
20.	27.205	X ⁵ - X ¹⁰	X ⁵ - X ¹⁴
21.	27.215	X ⁶ - X ⁷	X ⁶ - X ¹¹
22.	27.225	X ⁶ - X ⁸	X ⁶ - X ¹²
23.	27.255	X ⁶ - X ¹⁰	X ⁶ - X ¹⁴

I-624 Alignment Instruction

RECEIVER

- A. Inject at the ant. jack a 27.115MHz signal ($\pm .002\%$;30% modulation at 1KHz).
- B. Connect an audio voltmeter and oscilloscope across on 8 ohm load and plug into external speaker jack.

Test Equipment	Test Point	Adjust	Remarks
1. RF signal generator (low range to avoid audio saturation)	Inject at ant. jack	Channel sel to 13	
		T-101, T-102, T-103	Max. output with vol. control at max, squelch control at min. output should be more than 500mw (2.0 v/8 ohm) with gen. voltage at 1uV; S & N/N=more than 10dB on all channels

AGC RESPONSE

Set the output voltage of a signal generator at 50000uV and adjust the volume control so that the voltmeter output is 500mW (2.0v/8 ohms). Then, lower the output voltage of the generator so that the voltmeter output is 10dB down. The output voltage of the signal generator should be under 5 uV at this time.

SQUELCH

Set squelch control to maximum. Set signal generator to 500uV, and adjust VR103 so that squelch opens at 500uV signal level.

S-METER ADJUSTMENT

- A. Set RF signal generator to 100uV. Adjust VR104 until meter indicates "S-9".

DELTA TUNE

- A. Set the output voltage of a signal generator at 1 uV.
- B. Set the Delta Tune control at the center and the squelch control at minimum.
- C. Set the Volume Control so that 500mW may be attained on the voltmeter output. Then, with the Delta Tune control at the "+" side, vary the frequencies of the signal generator until the maximum voltmeter output is attained. Read the frequency variance of the signal generator. Do the same thing for the "-" side. Ascertain that the frequency variation is within ± 1 KHz to 2 KHz.

AUDIO POWER CHECK

With a generator output of 1mV and squelch control at minimum, audio output should be more than 4W(5.7v/8 ohm) at maximum position of volume control.

TRANSMITTER

- A. Power Supply –13.8VDC.
- B. Use a suitable power meter, non-inductive dummy load and oscilloscope connected to antenna jack.

Test Equipment	Test Point	Adjust	Remarks
1. Power Meter	antenna jack	T-201, T-202, L-203, L-204	Adjust for maximum output power.
2. Freq. Counter	across dummy load	-----	Check all channels \pm 800 Hz
3. A.F. Oscillator with AF voltmeter in shunt (1 KHz 10 mV)	Inject at mic input	VR-201	–90% modulation on oscilloscope
		-----	Reduce AF oscillator output to 5 mV; modulation \geq 50 %

- C. With 0% modulation and carrier power 3.5 to 4 Watts, adjust VR202 until meter reads between S9 and S10.

VOLTAGE ADJUSTMENT OF AC POWER SECTION

Set the output voltage of AC power section at 13.8 volts by adjusting VR501.

SPECIFICATIONS

1-624

GENERAL

1. Semiconductor : 25 Transistors, 133 Diodes and 1 IC
2. Frequency Range : 26.965 MHz – 27.255 MHz
3. Mode of Operation : AM
4. Controls : Calibration Control
: Fine Tune Control
: RF Gain Control
: Squelch Control
: Volume Control
5. Switches : Channel Selector Switch
: ANL-OFF Push Switch
: Tone Hi-Lo Push Switch
: PA-CB Push Switch
: AC-DC Push Switch
: Power ON-OFF Push Switch
: Bright-Dim Push Switch
6. Connectors and Jacks :

<u>Front</u>	<u>Rear</u>
: Microphone Connector	: Antenna Connector
: Headphone Jack	: EXT. Speaker Jack
	: PA Speaker Jack
	: Fuse-3A
	: DC Cord
	: AC Cord
7. Indicators : Digital Channel Indicator
: TX Lamp
: SIGNAL/TRANSMIT POWER METER
: SWR Meter
: Calibration Meter
8. Speaker : 3-1/2 inches, 8 ohms
9. Microphone : Dynamic Microphone, 500 ohms
10. Power Supply : 13.8 VDC Positive or Negative ground, 117 VAC
11. Dimensions : 14-1/16(W) x 5-7/16(H) x 10-5/8(D)
12. Weight : 13 Lbs. 8 Ozs.

RECEIVER

1. Sensitivity at S/N 10 dB : 0.5uV
2. Selectivity : 5 KHz
3. AGC Figure of Range : 80 dB
4. Squelch Range : 0.5uV – 500uV
5. Audio Output Power : 4 watts
6. Distortion Input 1000uV : 6%
7. Audio Frequency Response : 400 – 2000Hz
8. Spurious Response : More than 45 dB spurious signal is required to produce the same amount of audio output as the desired receive signal.
9. IF Frequency : 1st . . . 10.595 . . . 10.635 MHz – 2nd . . . 455KHz
10. Current Drain No Audio : 800 mA

TRANSMITTER

1. RF Output Power : 4 watts
2. Modulation Capability : Up to 98%
3. Harmonic Suppression : More than 50 dB
4. Current Drain : 1500 mA

1-624 PARTS LIST

REF. #	DESCRIPTION	PART #
	SEMICONDUCTORS	
Q 101	2SC674 transistor	
Q 102	2SC710 transistor	
Q 103	2SC711 transistor	
Q 104	2SC711 transistor	
Q 105	2SC711 transistor	
Q 106	2SA562 transistor	
Q 107	2SC372 transistor	
Q 108	2SC372 transistor	
Q 109	2SC372 transistor	
Q 110	2SC710 transistor	
Q 201	2SC710 transistor	
Q 202	2SC101B transistor	
Q 203	2SC756 transistor	
Q 204	2SB561 transistor	
Q 205	2SC372 transistor	
Q 206	2SC735 transistor	
Q 301	2SC735 transistor	
Q 302	TA 7062P I.C.	
Q 303, 304	2SD330 transistor	
Q 401	2SD313 transistor	
Q 501	2SD313 transistor	
Q 502	2SD330 transistor	
Q 503	2SC711 transistor	
D 101	10D-1 diode	
D 102	1S188 diode	
D 103	1S188 diode	
D 106	1S2075K diode	
D 107	HV-46 diode	
D 108	1S188 diode	
D 201	1S188 diode	
D 202	10D-1 diode	
D 203	10D-1 diode	
D 301	SV-9 diode	
D 302	10D-1 diode	
D 303	U05-B diode	
D 304	EQB01-09 diode (zener)	
D 501, 502	U05-B diode	
D 503	EQA01-08R diode (zener)	
D 504	EQA01-08R diode (zener)	
	COILS — INDUCTORS	
L 101	r.f. coil (49169)	2-0162
L 201	r.f. coil (49170)	2-0166
L 202	r.f. coil (4056)	2-0169
L 203	r.f. coil (49168)	2-0163
L 204	r.f. coil (49166)	2-0164
L 301	coil (LF5-223K)	2-0165
T 101	r.f. transformer (15089)	2-0049
T 102	r.f. transformer (15061)	2-0045
T 103	r.f. transformer (15090)	2-0050
T 201	r.f. transformer (20105)	2-0062
T 202	r.f. transformer (49167)	2-0161
T 1	modulation transformer (20015)	2-0156
T 2	driver transformer (1001)	2-0033
T 3	choke transformer (1002)	2-0030
T 501	power transformer (20014)	2-0059

1-624 Continued

REF. #	DESCRIPTION	PART #
	CASE PARTS	
	main cabinet (wood)	
	front panel (aluminum)	
	decoration plate (woodgrain)	
	decoration plate (plastic)	
	back cover	
	bottom chassis cover	
	cabinet feet	
	channel knob	
	volume knob	
	power on-off knob (round)	
	ANL knob (square)	
	bright-dim push knob (round)	
	CONTROLS	
VR101	volume control (50K)	
VR102	squelch control (10K)	
VR103	semi-fixed resistor (5K)	
VR104, 105	Δ tune, R.F. Gain control (10K)	
VR104	semi-fixed resistor (20K)	
VR201	semi-fixed resistor (10K)	
VR202	semi-fixed resistor (50K)	
VR501	semi-fixed resistor (200 Ω)	
VR601, 602	calibration control (5K)	
	ANL/TONE switch	
	PA-CB switch	
	Bright-dim switch	
	DC-AC/POWER switch	
	channel switch	
	MISCELLANEOUS	
	relay (NS2-P-DC12V)	
	455 KHz i.f. filter (CFU-455H)	
	10.7 MHz i.f. filter (SFE 10.7 MA)	
	S/RF meter	
	calibration meter	
	SNR meter	
	meter-tx lamp	
	headphone jack	
	mic jack	5-501
	antenna jack	5-502
	ext. spkr./PA jack	5-503
	fuse socket	
	a.c. cord	
	d.c. cord	
	heatsink 2SC756)	
	heatsink (2SD330 audio)	
	heatsink (2SD313 power supply)	
	speaker	
	Stanley seven-segment readout	
	crystal oscillator unit	
	RESISTORS — CAPACITORS	
	Refer to schematic for specific values	